

# Haier

## COMBINED 21" TV AND DVD PLAYER

---

### OWNER'S MANUAL

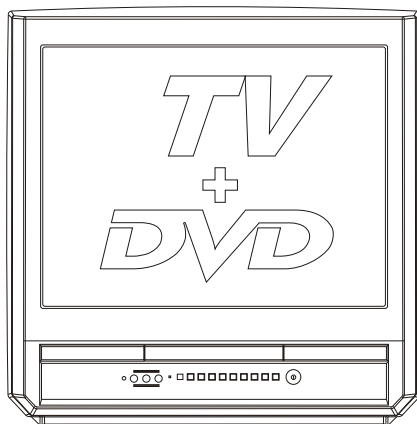

Please read this manual carefully before using this TV set and keep it for future reference.

The Owner's Manual for the Follow Models:  
**DTA-2198, DTA-2198PF**

# CONTENTS

## Before Operation

<b>Warning and cautions</b> .....	2
<b>Installation</b> .....	3
Aerial connection.....	3
Preparation of the remote control unit.....	3
<b>Function buttons and external sockets</b> .....	4
Front panel of the TV set.....	4
Rear panel of the TV set.....	4
<b>Buttons on the remote control</b> .....	5

## Basic operation

<b>Switching on/off the TV set</b> .....	6
<b>Watching TV program</b> .....	7
Watching TV program.....	7
Program swap and auto scan functions.....	8
<b>Searching channel</b> .....	9
Full automatic search mode.....	9
Semi-automatic search.....	10
Manual fine tune.....	11
Program skip.....	12
<b>Convenient picture and sound control functions</b> .....	13
Multiple picture modes.....	13
Black stretch and noise reduce.....	14
Mute function.....	15
<b>Time functions</b> .....	16
Clock setting and timer on/off functions.....	16
Sleep timer and program preset.....	17
<b>Setup function</b> .....	18
Screen saver and child lock functions.....	18
AVL and calendar functions.....	19
Fade.....	20
<b>Position exchange function</b> .....	21

## DVD Operation

<b>Basic Playback</b> .....	22
<b>Advanced Playback</b> .....	23
<b>Special Function Playback</b> .....	24
<b>DVD System Setup</b> .....	25
<b>Playable Discs</b> .....	29
<b>Disc Protection and DVD Characteristics</b> .....	30

## Others

<b>Connection to the external audio and video equipment</b> .....	31
<b>Troubleshooting guide</b> .....	32
<b>Specifications</b> .....	33

## Warning and cautions

1. When you clean the TV set, please pull out the power plug from AC outlet. Don't clean the cabinet and the screen with benzene, petrol and other chemicals.



4. Do not place the TV set near rain or moisture as it may cause an electric shock, or the TV set to catch fire. The TV set must only be used in dry in door locations.

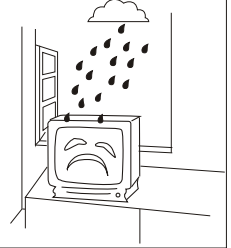

2. In order to prolong the using life of the TV set, please place it in a well ventilated location.

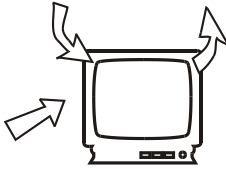

5. The back cover must only be removed by a registered electrical service person. Removing the back cover may result in electric shock, fire or damage to the TV set.

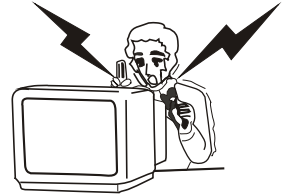

3. Don't place the TV set in direct sunlight or near a heat source.

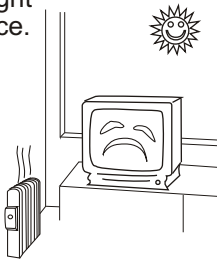

6. If the TV set is not going to be used for a long time, or there is a severe thunder & Lighting storm, it is recommended that the TV set be disconnected from the AC power outlet and the aerial plug removed.

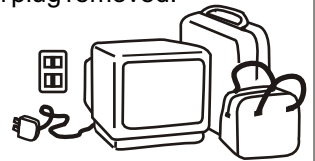

### Explanation on the display tube

Should the picture tube require cleaning, disconnect the power and use a dry soft cotton cloth. Do not use any cleaner or abrasive cloths.

# Installation

## Aerial connection

For an optimum high quality picture, it is strongly advised that the TV set connect to an external aerial(s) using high quality coax cable. When connecting to HiFi VCRs, satellite (or cable) set top boxes, that the AV terminals are used to allow the stereo sound to be transferred.

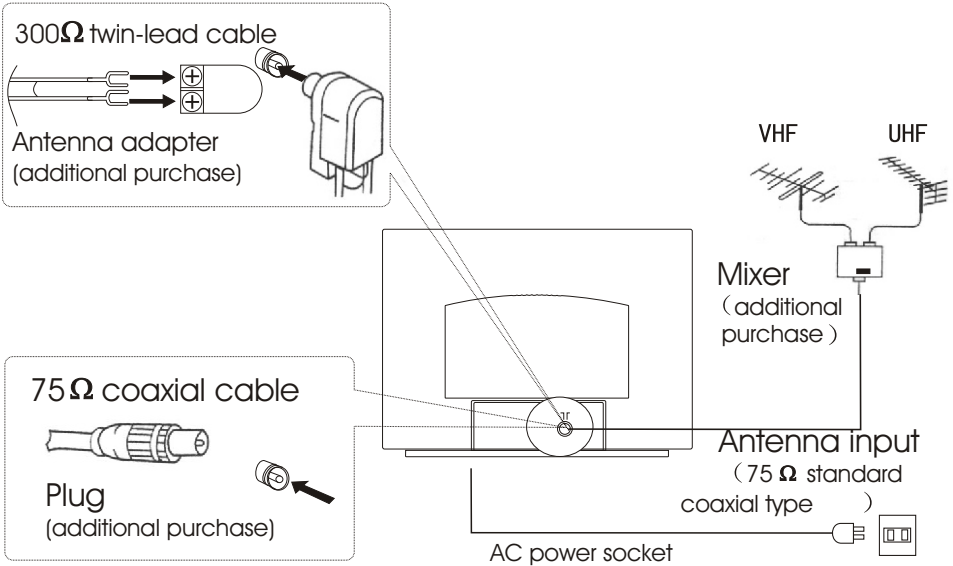

## Preparation of the remote control unit

### Battery installation

Take off the battery compartment cover. Place two AA batteries, make sure that battery polarity matches with the +/- mark inside the battery compartment.

### Operation notes for the remote control unit

- Under normal conditions, the life time of batteries is one year.
- If you don't intend to use the unit for a long period or the electricity of the batteries is used up, remove the batteries to prevent batteries acid from leaking into the battery compartment.
- **Never place batteries in a fire.**
- Avoid dropping the remote control and/or getting it wet.

# Function buttons and external sockets

## Front panel of the TV set

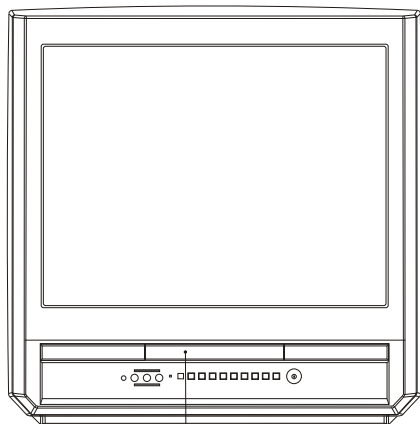

The DVD Player

### Front AV

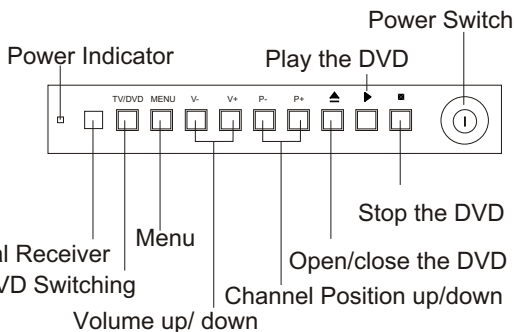
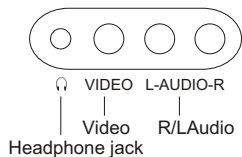

## Rear panel of the TV set

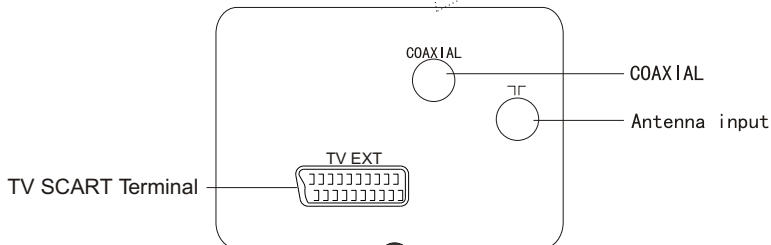
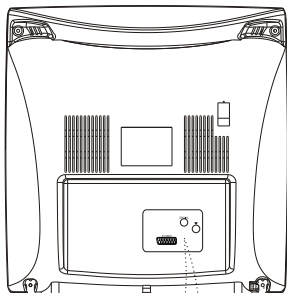

# Buttons on the remote control

## Buttons on the remote control

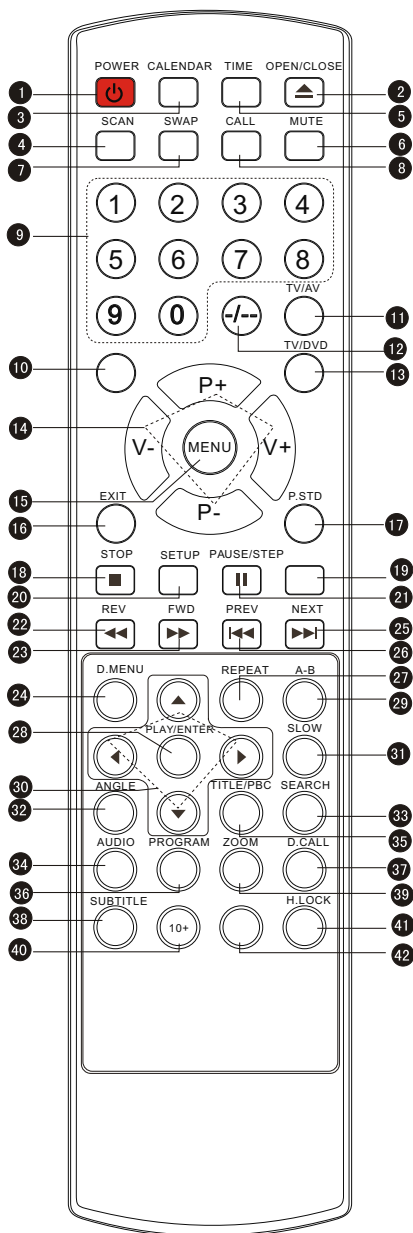

- 1 Stand By
- 2 DVD Open/close
- 3 (Not available)
- 4 Scan
- 5 Time Menu
- 6 Mute
- 7 Former Program
- 8 Call Screen Display
- 9 Program Number
- 10 (Not available)
- 11 TV/AV Exchange
- 12 Digital Selector
- 13 TV/DVD
- 14 Volume/Channel Selection
- 15 MENU
- 16 Exit Screen Display
- 17 Picture Mode
- 18 DVD STOP
- 19 (Not available)
- 20 DVD SETUP
- 21 DVD PAUSE/STEP
- 22 DVD FAST REVERSE
- 23 DVD FAST FORWARD
- 24 DVD MENU
- 25 DVD NEXT
- 26 DVD PREVIOUS
- 27 DVD REPEAT
- 28 DVD PLAY/ENTER
- 29 DVD A-B REPEAT
- 30 DVD Cursor Move button
- 31 DVD SLOW
- 32 DVD ANGLE
- 33 DVD SEARCH
- 34 DVD Audio
- 35 DVD TITLE
- 36 DVD PROGRAM
- 37 DVD CALL
- 38 DVD SUBTITLE
- 39 Zoom
- 40 DVD 10+
- 41 (Not available)
- 42 (Not available)

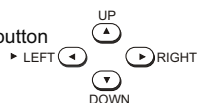

## Switching on/ off the TV set

- In the following, the methods of using power switch and remote controller to switch on/off power supply for the TV set will be explained.

### Switching on/ off the TV set

#### Switching on/ off the TV set

1 Please press the power switch to switch on AC power supply and the power indicator will light.

2 If the indicator is lighting in red, press the button  on the remote control again.

Note:

1 When you don't operate the TV set with a remote control, you can turn on it directly through pressing the P+/- buttons on the TV set (Child Lock must be turned off).

4  
AUTO  
DK

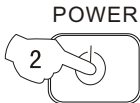

2 If you want to exchange to standby status, please press down the POWER button on the remote control.

3 If you want to fully switch off the power supply for the TV set, please press the power switch button on the TV set.

#### Auto switch-off function

When the "Back" function is on, if an empty channel is selected or the TV programs are ended for the day, the power will be switched off 5 minutes later automatically. If the "OFF TIME" is on, it will be switched off according to the presetting time. The auto power off function does not work under video input or when the background is off.

(Note: If the "off timer" is less than 5 minutes, it will be switched off automatically to the preset Time. )

# Watching TV

- You can watch TV program in a preset channel.

## Watching TV program

### How to select TV program

#### Select the desired program

##### 1 Using "Program number" buttons

- Directly enter the channel number with the numeric keypad on the remote control.
- To select channel numbers from 10 ~ 99 press [-/--] button and enter the two digit channel number
- To select channel numbers from 100 ~ 218 press [-/--] button twice and enter the 3 digit channel number

##### 2 Using the P+/- buttons





- Press the P+ button to select a channel number in number increasing direction.
- Press the P- button to select a channel number in number decreasing direction.

#### Select the desired sound

Press the V+/- buttons on the remote or the front of the TV set to adjust the volume level. The range is 0~99. When the volume buttons are pressed the volume level is displayed automatically on the TV screen.

#### If the colour or sound of a channel is abnormal

Usually this should be set in the Auto position. However if the colours displayed on the screen are incorrect you can manually select the correct colour system. When finish remember to turn it back to auto again so that other programs will still work correctly. To select the colour change option press the MENU button on the remote control.

				
TUNE	COLOUR	BAND	SKIP	PROGRAM
				SEARCH
				FINE TUNE
				AUTO SEARCH
	AUTO	BG	VHFL	OFF
				0

- If picture colour is abnormal  
Use the P+/- buttons to select Colour then the V+/- buttons to change between Auto, PAL, NTSC, SECAM and NTSC443. Press the EXIT button to save the setting.
- If the picture sound is abnormal  
Use the P+/- buttons to select Sound then press the V+/- buttons to select the sound system.

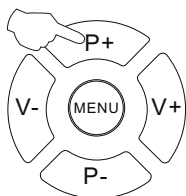
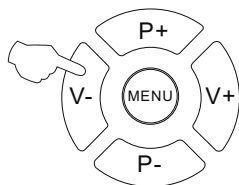
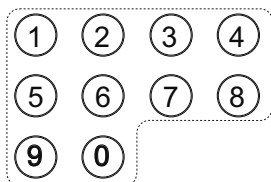



## Watching TV (continued)

- Swap function enables quick swap to the last watched program.
- Auto scan function enables automatic successive scanning of all the programs in memory with "OFF" skip status (each channel will last about 2 seconds).

### Program swap and auto scan functions

#### Program swap

1 Suppose the channel number you used just now is 8 and the channel number you are using is 18 (as shown in the figure).

18  
AUTO  
DK

2 If you want to return to the last watched program channel 8, you can simply press the SWAP button.

8  
AUTO  
DK

3 If you want to return to channel 18, press the button again. Through this function, you can easily change between the channel you are using and the channel you used last time.

18  
AUTO  
DK

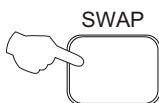

#### Auto program scan

1 If you want to select a desirable program, you may scan all the TV programs in memory. You can simply press the SCAN button to do this. The program numbers will appear one after another from beginning to end (each channel number will last about 2 seconds).

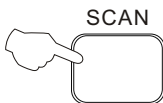

2 If you want to stop the function during auto scanning, simply press the SCAN button again.

# Searching channel

- This TV set has three methods to set the channels, which are respectively full automatic, semi-automatic and manual fine tune.
- In this section, how to use the remote control to set the channel is explained. You can also use the buttons on the TV set to set channel.

## Full automatic mode

### Automatic search

1 Press the MENU menu button , till the TUNE menu shown on the right display on the screen.

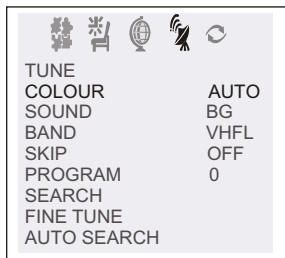
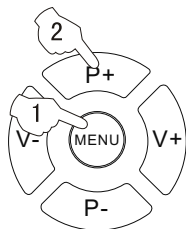

2 Press the P+/- buttons to select "AUTO SEARCH".

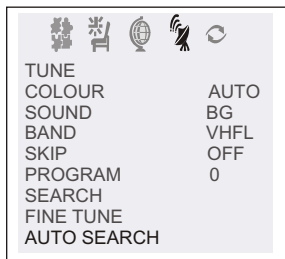

3 Press the V+ button to ensure automatic search function operates. All channels now playing program will be automatically preset in order . After the search has finished, the first program number will display on the screen.

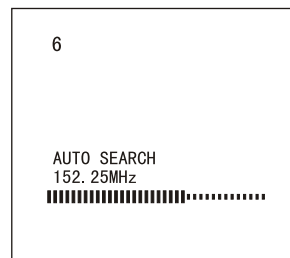
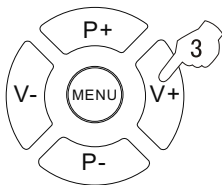

### Display function

Press the CALL button, then the channel number and the systems will be displayed on the screen.

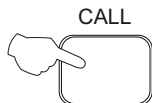

# Searching channel

(Continued)

## Semi-automatic search

### Semi-automatic search

1 Press the P+/- buttons or PROGRAM NUMBER (0-9) buttons to choose desired channels (I.E. channel 1).

1  
AUTO  
DK

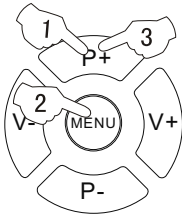

2 Press the TUNE menu button, till the TUNE menu shown on the right display on the screen.

3 Press the P+/- buttons to select "SEARCH".

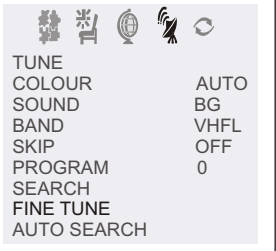

4 Press the V-/+ buttons to start searching.

The V- (down) button is used for lower side program search.  
The V+ (up) button is used for higher side program search.

Repeat this step, till find the desired channel.

1

SEARCH  
152.25MHz



### To turn off the on-screen menu

In general, after you press the MENU button, the menu item display (PICTURE, TIME, FUNCTION, TUNE, EXCHANGE, ETC.) will automatically disappear within 15 seconds. If you want to eliminate these contents immediately, please press the EXIT button.





# Searching channel

(Continued)

## Program skip

### Program skip

The Program skip feature enables you to skip/hide programs that you do not wish to be displayed when using the P+/- buttons. These channels will still be displayed by directly using the channel number buttons on the remote control.

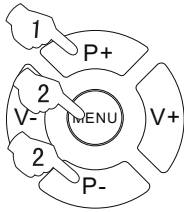

1 Press the P+/- buttons or PROGRAM NUMBER (0-9) button to choose desired channels (I.E. channel 1) .

1  
AUTO  
DK

2 Press the MENU menu button till the TUNE menu shown on the right display on the screen.

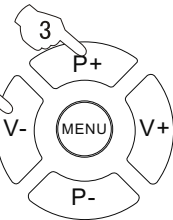

3 Press the P+/- buttons to select "SKIP".

TUNE	COLOUR	SOUND	BAND	SKIP	PROGRAM	SEARCH	FINE TUNE	AUTO SEARCH

4 Press the V-/V+ buttons to turn the SKIP function "ON".

TUNE	COLOUR	SOUND	BAND	SKIP	PROGRAM	SEARCH	FINE TUNE	AUTO SEARCH

5 Press the TUNE button to close the menu. When you use the P+/- buttons to select channel, this channel will be skipped. However, you can still use the PROGRAM NUMBER buttons to select the skipped channel numbers.

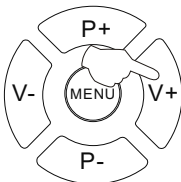

### If you want to recover the skipped channel

- 1 Use the PROGRAM NUMBER buttons to select the channel number to be recovered.
- 2 Repeat those steps just now.
- 3 Press the V-/V+ buttons to turn the SKIP function "OFF".

# Convenient picture and sound control functions

## Multiple picture modes



### How to select picture modes

You can quickly select the desired picture mode from four preset modes and one customized mode.

Press the P.STD button to select the desired picture quality. Five kinds of picture modes (i.e., "STANDARD", "RICH", "USER", "LISTEN", "SOFT") can be selected in turn.

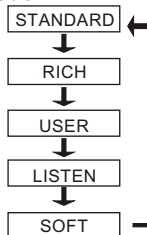

The 5 modes are

- Listen-This is a new feature that blacks out the TV screen when listening to music only channels;
- Soft-Designed for night time low light viewing;
- Standard -Designed for rooms that have good all round lighting;
- Rich-Designed for rooms with high ambient lighting such as daytime sport;
- User-A spare setting that can be adjusted to personal tastes.

### How to customize your own picture status

1 Press the MENU menu button, till the PICTURE menu shown on the right display on the screen.

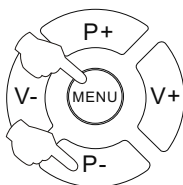

2 Press the P+/- buttons to select the item to adjusted, then press the V-/+ buttons to obtain the desired effect.

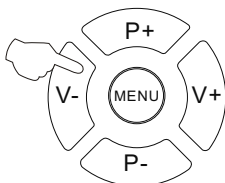
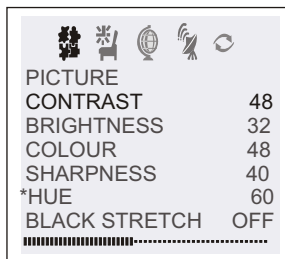

ITEM	Press V-	Press V+
CONTRAST	Weak	Strong
BRIGHTNESS	Dark	Bright
COLUOR	Shallow	Deep
SHARPNESS	Soft	Sharp
*Hue	lean to purple	lean to green

Note:

The "Hue" item only appears when the colour system is NTSC.

# Convenient picture and sound control functions

(Continued)

- Black Stretch-(Automatically Increases the Contrast Rage)
- Noise Reduce - (Picture Noise & Grain Reduction Circuit. Only use on poor reception.)

## Black stretch and noise reduce

### How to select BLACK STRETCH

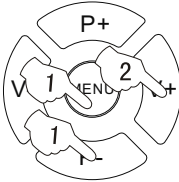

1 Press the MENU menu button , till the PICTURE menu shown on the right display on the screen.

PICTURE	
CONTRAST	48
BRIGHTNESS	32
COLOUR	48
SHARPNESS	40
*HUE	60
BLACK STRETCH	OFF

2 Press the P+/- button to select "BLACK STRETCH".

PICTURE	
CONTRAST	48
BRIGHTNESS	32
COLOUR	48
SHARPNESS	40
*HUE	60
BLACK STRETCH	ON

3 Press the V-/+ buttons to turn the BLACK STRETCH function "ON" or "OFF".

### How to select NOISE REDUCE

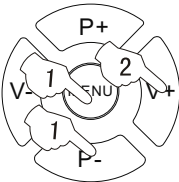

1 Press the MENU menu button, till the FUNCTION menu shown on the right display on the screen.

FUNCTION	
ENGLISH	
BACKGROUND	ON
NOISE REDUCE	ON
FADE	ON
AVL	ON
CALENDAR	

2 Press the P+/- buttons to select "NOISE REDUCE".

FUNCTION	
ENGLISH	
BACKGROUND	ON
NOISE REDUCE	ON
FADE	ON
AVL	ON
CALENDAR	

3 Press the V-/+ buttons to turn the NOISE REDUCE function "ON" or "OFF".

## Convenient picture and sound control functions

(Continued)

### Mute function

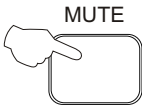

### Sound mute

1 Press the MUTE button on the remote control and "MUTE" type face will display on the lower part of the screen. At this time, the sound of the TV set is turned off.

MUTE

2 If you want to recover the sound, press the MUTE button again or directly press the V-/± buttons.



## Clock setting and timer on/off functions

### Clock setting

The clock will only work if the TV set is left turned on or in standby. When the set is disconnected from the power supply or is turned off by the main power on the front panel, the clock loses power and will need to be reset when the power is reconnected.

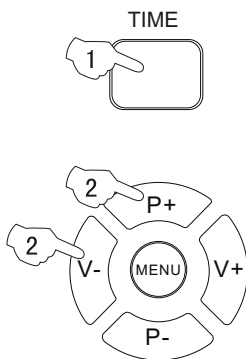

1 Press the TIME menu button, and the TIME menu display on the screen.

TIME	
CLOCK	17:18
ON TIME	18:00
ON PROG	1
OFF TIME	--:--
SLEEP TIMER	0
REMIN TIME	--:--
REMIN PROG	1

2 Press the P+/- buttons select "CLOCK", then press the V -/+ buttons to adjust the time in hour position; press again the P+/- buttons to select the time in minute position, then press the V-/+ buttons to adjust the value of minutes .

### On/off timer

Using on/off timer function, the TV set can automatically turn on to a preset program or shut down in a preset time.

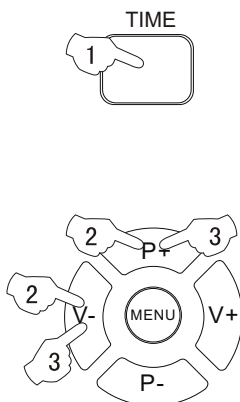

1 Press the TIME menu button to call up the TIME menu on the screen.

TIME	
CLOCK	17:18
ON TIME	18:00
ON PROG	1
OFF TIME	--:--
SLEEP TIMER	0
REMIN TIME	--:--
REMIN PROG	1

2 Press the P+/- buttons to select "ON TIME", then press the V -/+ buttons to set the value in hour position; press again the P+/- buttons to select the minute position and set the value of the minute.(take 18:00 as an example)

3 Press the P+/- buttons to select "ON PROG", then press the V-/+ or program direct number buttons to select your desired channel (take 8 as an example).

TIME	
CLOCK	17:18
ON TIME	18:00
ON PROG	8
OFF TIME	23:00
SLEEP TIMER	0
REMIN TIME	--:--
REMIN PROG	1

4 Repeat step 1-2 to set OFF TIME.(take 23:00 as an example)

# Time functions

## (Continued)

### Sleep timer and program preset

#### Sleep timer

The TV set have 18 sections option for sleep timer function (each section has a time interval of 10 minutes) (See right chart):

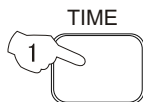
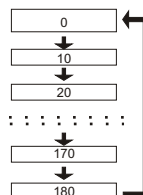

1 Press the TIME menu button, and the TIME menu display on the screen.

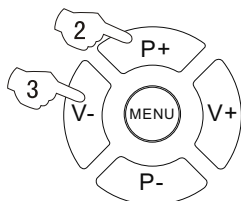

2 Press the P+/- buttons to select "SLEEP TIMER".

3 Press the V-/+ buttons to adjust the SLEEP TIMER level.

TIME	17:18
CLOCK	18:00
ON TIME	18:00
ON PROG	8
OFF TIME	23:00
SLEEP TIMER	120
REMIND TIME	--:--
REMIND PROG	1

#### REMIND PROG function

Program remind timer, that displays an on-screen reminder prompt, when a program on a different channel is due to start.

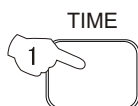

1 Press the TIME menu button to call up the TIME menu on the screen.

2 Press the P+/- buttons to select "REMIND TIME", then press the V-/+ buttons to set the value in hour position; press again the P+/- buttons to select the minute position, and then set the value of the minute. (take 19:00 as an example)

TIME	17:18
CLOCK	18:00
ON TIME	18:00
ON PROG	8
OFF TIME	23:00
SLEEP TIMER	120
REMIND TIME	19:00
REMIND PROG	1

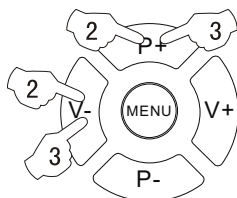

3 Press the P+/- buttons to select "REMIND PROG", then press the V-/+ buttons or the program direct number buttons to set the desired channel (take 18 as an example).

TIME	17:18
CLOCK	18:00
ON TIME	18:00
ON PROG	8
OFF TIME	23:00
SLEEP TIMER	120
REMIND TIME	19:00
REMIND PROG	18

NOTE: For REMIND PROG to operate CHILD LOCK must be turned off.

# Set up function

## Screen saver and childlock functions

### How to start screen saver function

When the BACKGROUND function is ON, the screen will turn automatically as shown "NO SIGNAL" of moving ( black background).

NO SIGNAL

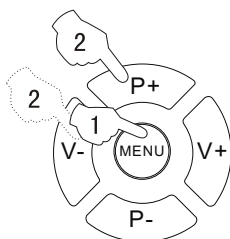

1 Press the MENU menu button, till the FUNCTION menu shown on the right display on the screen.

2 Press the P+/- buttons to select "BACKGROUND" and press the V-/+ buttons to turn the BACKGROUND function "ON".

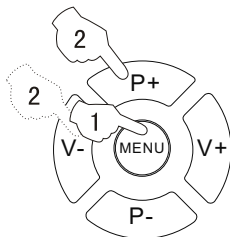
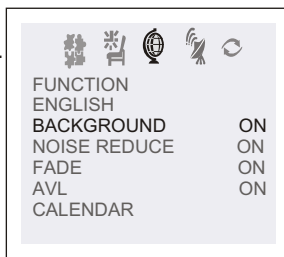

# Set up function

(Continued)

## AVL and calendar functions

### AVL function

Automatic Volume Limit control reduces effect of large volume changes such as when the ads come on.

1 Press the MENU menu button, till the FUNCTION menu shown on the right display on the screen.

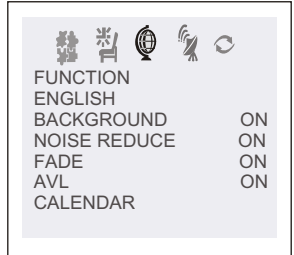

2 Press the P+/- button to select "AVL" .

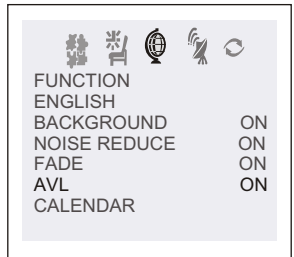

3 Press V-/+ button to turn the AVL function "ON" or "OFF".

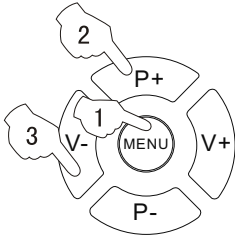

### Calendar function

Enables the TV sets internal calendar to be set.

1 Press the MENU menu button, till the FUNCTION menu shown on the right display on the screen.

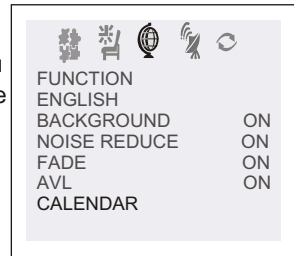

2 Press the P+/- button to select "CALENDAR", then press the V-/+ buttons to the CALENDAR display on the screen.



3 Press the P+/- buttons to turn the YEAR/MONTH/DAY, press V-/+ buttons to set or adjust the YEAR/MONTH/DAY.

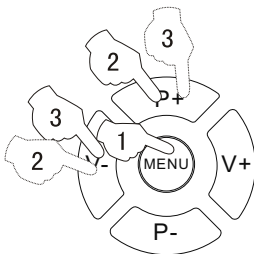

# Set up function

(Continued)

## Fade

### Fade

The FADE control allows time for the picture tube to warm up and gently turned on, which can help prolong the life of the picture tube.

1 Press the MENU menu button, till the FUNCTION menu shown on the right display on the screen.

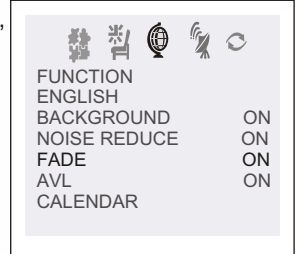
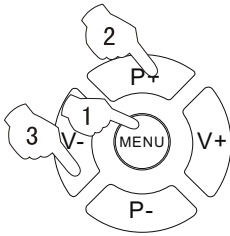

2 Press the P+/- buttons to select "FADE".

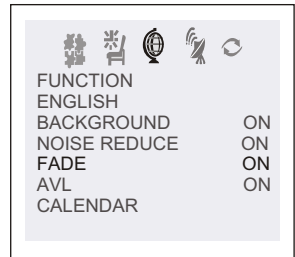

3 Press the V-/+ button to turn the FADE function "ON" or "OFF".

# Position exchange functions

## Exchange

### Exchange

This feature enables TV programs that may be on a wrong TV channel number to be swapped/exchanged. This feature is very useful when Automatic Search Tuning has been used, to reallocate the found programs to the correct channel numbers.

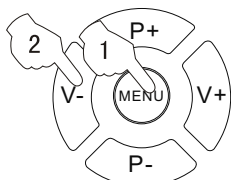

1 Press the MENU button again (6 times), till the EXCHANGE menu display on the screen.

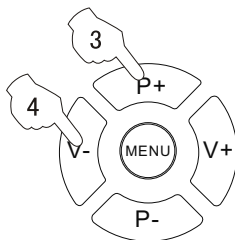

2 Press the V-/V+ buttons or the PROGRAM NUMBER (0-9) buttons to set PROGRAM 1 TO 6.

3 Press the P-/P+ buttons to select "PROGRAM 2".

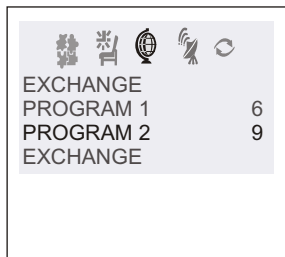

4 Press the V-/V+ buttons or the PROGRAM NUMBER (0-9) buttons to set PROGRAM 2 TO 9.

5 Press the P-/P+ buttons to select "EXCHANGE".

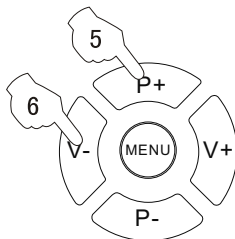

6 Press the V-/V+ buttons to set "EXCHANGE".

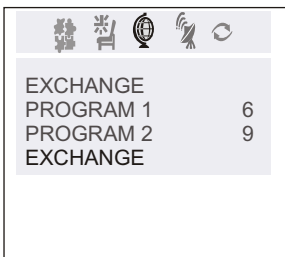

# Basic Playback

## Basic Playback

### Preparations

- Press the TV/ DVD button on the remote control or the TV to turn on the DVD player.

### Basic playback

1. Press OPEN/CLOSE to open the disc tray, place a disc on the disc tray.  
There are two different disc sizes. Place the disc in the correct guide on the disc tray. If the disc is out of the guide, it may damage the disc and cause the DVD player to malfunction.
  - Do not place a disc which is unplayable in this DVD player (see "Playable discs").
2. Press OPEN/CLOSE to close the disc tray, the playback will automatically start.
  - Some discs do not start automatically. Press PLAY/ENTER to start playback.
3. Some discs may start playback with a menu. Use the cursor buttons on the remote control to select menu options and press PLAY/ENTER to start. You may also press the digit buttons to select a menu option directly. Many DVDs will not allow this during start-up.

### Pause playback

1. Press PAUSE/STEP to pause playback (still mode).  
The sound will be muted during still mode.
2. Press PLAY/ENTER to resume normal playback.

### Stop playback

1. Press STOP ■ button to go to stop mode, the TV screen will show the start logo. For some discs the player can recall the location where stopped, such as DVDs and audio CDs.
2. Press PLAY/ENTER to resume play-back from the location where playback was stopped.
3. Press STOP twice to stop completely.  
Play must then resume from the title beginning.

### Previous and Next

During Playing, pressing the PREVI◀◀ key will restart the current chapter and skip chapters backwards with each subsequent press until the start of the disc is reached.  
Each press of NEXT ▶▶ key during playing will skip the current chapter and play the next one.  
In the case of CD audio and photo discs the next track, song or photo is selected.

### Fast forward and Fast reverse

1. Press FWD ▶▶ to fast forward through the disc.  
Each time the FWD ▶▶ button is pressed, the fast forward motion speed changes.
2. Press PLAY/ENTER to resume normal playback.
3. Press REV ◀◀ to fast reverse through the disc.  
Each time the REV ◀◀ button is pressed, the fast reverse motion speed changes.
4. Press PLAY/ENTER to resume normal playback.

### Single step playback

1. When paused, press PAUSE/STEP repeatedly to single step forward frame by frame in the video.
2. Press PLAY/ENTER to resume normal playback.

# Advanced Playback

## Advanced Playback

### IMPORTANT NOTE:

ALL DESCRIBED FUNCTIONS ARE FOR DVD DISCS. There will be some differences for other kinds of disc.

#### SUBTITLE

Press "SUBTITLE", the screen will display "SUBTITLE 01/XX XXXXX", "01" indicates the ordinal number of this language; "XX" indicates total number of language; "XXXXXX" indicates the language of country. (the number of language depends on disc). This function can select up to 32 languages displayed on screen.

#### REPEAT

Press "REPEAT" and Chapter repeat will be displayed on screen, the second press will display Title repeat, the third press will display All repeat, the fourth press will cancel this function.

#### A-B

Press A-B to select the Start point. Press again to select the End point. A third press will cancel the function.

#### ANGLE

When enjoying sports, concert or theatre, press this key to watch same actions in different angles. (Valid for discs possessing this function) Using a disc recorded in multi-angle you can view the scene from different angles, for example, front, side, whole view and exterior scene.

#### D.MENU

Press this key to display root menu, select item according to your preference. (This function will work with a DVD having a multi-layer menu.)

#### D.CALL

Pressing this key will cycle through "title elapsed", "title remain", "chapter elapsed", "chapter remain" and "display off". Each displays the appropriate time information.

#### PROGRAM

When playing discs, press "PROGRAM" to enter program mode. Starting with program number "01" highlighted, press the digit buttons to select the title and chapter number that you want. When finished move the cursor to select "START". This will start the program playback.

#### SEARCH

Press "SEARCH" once to display Disc Go To --:--, use numeric key to enter the desired time of Disc. Press "SEARCH" twice to display Track Go To --:--, use numeric keys to enter the desired time of track. Press "SEARCH" 3 times to display Select Track --/03, use numeric keys to enter the desired track.

#### SLOW

Press SLOW to play a disc in slow forward. Each time the SLOW button is pressed, the slow motion speed changes. Press PLAY/ENTER to resume normal playback;

**Note:** This function is invalid for CD.

#### TITLE/PBC

With some DVD discs pressing this key will display the title menu. You can then use the digit buttons to select the item you prefer.

#### AUDIO

Press this key can change the audio mode. such as: Audio 1/2: AC 3 2 CH English  
Audio 2/2: AC 3 5.1 CH English  
For CD audio, press this button to cycle between Mono Left, Mono Right, Mix-Mono and Stereo.

**Note:** When press this button continuously, you must above 3 seconds interval.



## Special Function Playback

### JPEG DISC PLAYBACK

When a disc containing standard JPEG picture files is inserted into the player, a navigation menu will be displayed automatically. Use the UP and DOWN cursor buttons to select a file then press PLAY/ENTER. The slide show will commence. Press PREVIOUS or NEXT to move between pictures. Press pause to stop on the current picture. Press PLAY/ENTER to resume normal playing.

JPEG disc contains with JPG-format picture information which can be decoded by micro-computer software and output through video output interface for enjoying on TV screen. Such function can be used in many domains. For example, in education, teachers can change those pictures for class into JPG-format file by digital camera or scanner, which is commonly used in computer, and record them into CD-R disc through disc recorder. It will be convenient for and direct to the students when teachers play the disc by TV set or other equipment in class. That reduces teachers' repetition work and good for reservation (information in disc can be reserved for more than 100 years); in family, users can record pictures which formed by digital camera or scanner into CD-R disc. Suppose one picture occupies about 100K bytes, then one disc may record about 6000 pictures; in commerce, manufacturers can show the products pictures one by one to consumers.

**NOTE:** The actual content will be different as per disc.

### SCREEN SAVER FUNCTION

This unit employs a screen saver mode to help protect the tube during static video pictures. This can be turned off on the GENERAL SETUP PAGE (see Pg. 26)

# DVD System Setup

## DVD System Setup

### General Setup Process

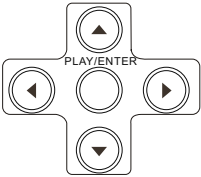
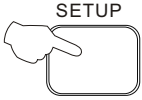

1. Press the SETUP button, the General Setup Page, Preference Page will be displayed in turn.

2. Press ▲ or ▼ to select the item, then press ► to enter the submenu.

3. Press ▲ or ▼ to setup, then press PLAY/ENTER to confirm.

4. Press SETUP button to exit the menu.

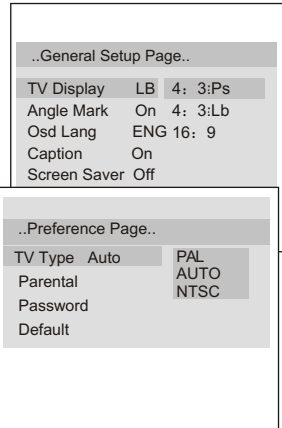

### General Setup Page

#### ASPECT RATIO DESCRIPTION

When using the DVD with the internal TV, select 4: 3/LB.

*The following information applies only when the DVD output is connected to an external TV.*

- 4: 3/PS (PS = Pan and Scan)

You may select if you have a normal aspect ratio (4:3) TV, although the NORMAL/LB (letter box) is a more common choice. In PS

mode, widescreen material will fill the screen, but at the expense of chopping off extreme left and right edges of the original film picture. For this feature to work, the disc must be specially coded. Such discs are uncommon.

- 4: 3/LB (LB = Letter Box)

You may select this if you have a normal aspect ratio (4:3) TV. Widescreen material will be shown in pure unaltered form, allowing the entire picture area of the original film to be viewed without any side cropping. Black bars will appear above and below the picture.

- 16: 9

You may select this if you have a widescreen (16:9) TV. Black bars may still appear above and below the picture even if using a widescreen TV. This is because some film directors prefer to use ultra widescreen aspect ratios e.g. 2.35:1. This will normally be indicated on the DVD packaging.

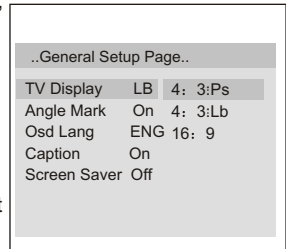
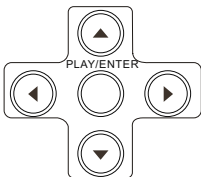
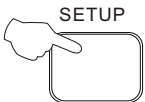

# DVD System Setup(Continued)

## DVD System Setup

### General Setup Page

**ANGLE MARK:** Users can select a particular camera angle when playing a DVD which offers multiple angles.

This item allows you to set Angle Mark ON or OFF.

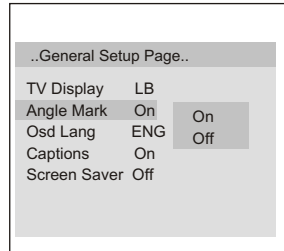

**On Screen Display (OSD) Language:** The TV on-screen display language is English.

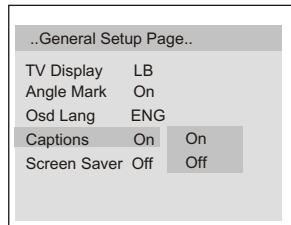

**CAPTIONS:** This function allows you to display or hide the caption.

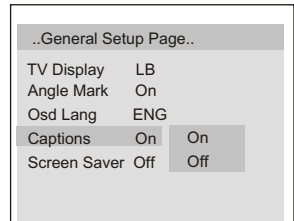

**SCREEN SAVER:** If the screen saver is on, then there will be an animated picture of DVD on the screen whenever the DVD player is idle for more than 3 minutes .

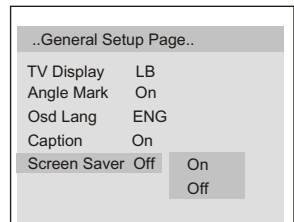

# DVD System Setup(Continued)

## DVD System Setup

### Preference Page

The Preference Page is only available when there is no disc in the player. These settings are applied consistently to all discs which are inserted and played.

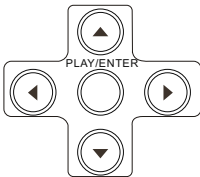
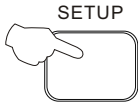

**TV TYPE:** This player supports different TV output, including MULTI(Auto), NTSC, and PAL systems. Usually please set to MULTI.

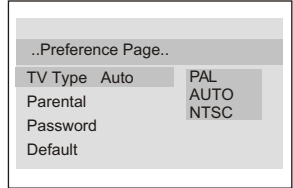

**PARENTAL:** The parental control function works in conjunction with the different censorship classes assigned to DVDs. These classes help to control the types of DVDs that the family watches, There are up to 8 censorship classes for DVDs.

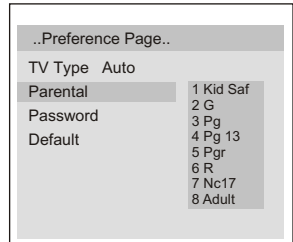

#### Note:

- 1 To change this setting you must enter your password. (Initial password is 1234)
- 2 When set to OFF, all discs may be viewed.

#### PASSWORD CHANGE:

You can change your password by entering 4 digits. You must confirm the 4 digits before the new password can be accepted.

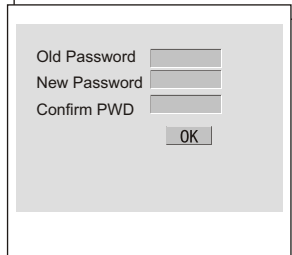
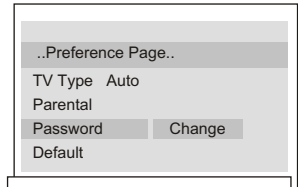

NOTE:If you forget your password or a password is accidentally set enter 1369 as the password. This will enable you to regain control.

# DVD System Setup(Continued)

## DVD System Setup

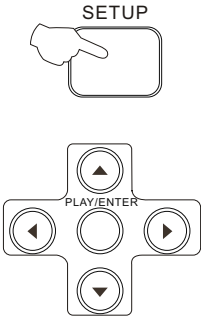

**DEFAULT:** Resets all settings (except password and parental lock status) for this DVD player back to the manufacturers original settings. Press ENTER to perform the reset.

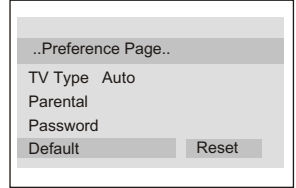







**Note:**

Some functions may not be available depending on the type of disc.

## Playable Discs

The following discs can be played:

DISCS	LABEL	CONTENTS	DIMENSION
DVD VIDEO		Audio +Video (moving picture)	12cm
			8cm
SVCD		Audio +Video (moving picture)	12cm
			8cm
VIDEO-CD (VCD)		Audio +Video (moving picture)	12cm
			8cm
AUDIO CD		Audio	12cm
			8cm
HDCD		Audio	12cm
			8cm
JPEG		Video(picture)	12cm
			8cm
KODAK CD		Video(picture)	12cm
			8cm
CD-R	<b>CD•R</b>	Audio or Video (moving picture)	12cm
			8cm
CD-RW	<b>CD-RW</b>	Audio or Video (moving picture)	12cm
			8cm
<b>CD+G</b>	<b>CD+G</b>	Audio(picture)	12cm
			8cm

- You cannot play discs other than those listed above.
- You cannot play discs of non-standardized discs, even if they may be labelled as above.
- The performance of CD-R or CD-RW disc is depend on the way of disc-burning. In a few cases, their performance may be not very well or even no performance.

# Disc Protection and DVD Characteristics

## ON HANDLING DISCS

- Do not touch the playback side of the disc.
- Do not attach paper or tape to disc.

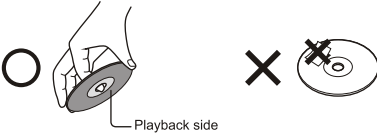

## ON CLEANING DISCS

- Fingerprints and dust on the disc cause picture and sound deterioration. Wipe the disc from the centre outwards with a soft cloth. Always keep the disc clean.



- If you can not wipe off the dust with a soft cloth, wipe the disc lightly with a slightly moistened soft cloth and finish with a dry cloth.
- Do not use any type of solvent such as thinner, benzene, commercially available cleaners or anti-static spray for vinyl Lps. It may damage the disc.

## ON STORING DISCS

- Do not store discs in a place subject to direct sunlight or near heat source.
- Do not store discs in place subject to moisture and dust such as a bathroom or near a humidifier.
- Store discs vertically in a case. Stacking or placing object on discs outside of their case may cause warping.

## STRUCTURE OF DISC CONTENTS

Normally, DVD discs are divided into titles, and the titles are sub-divided into chapters. Audio CD are divided into tracks.

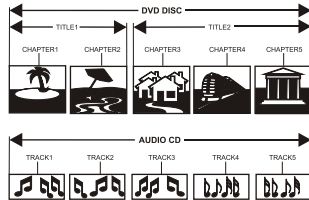

Each title, chapter, or track is assigned a number, which is called title number, chapter number or track number respectively.

There may be discs that do not have these number.

## Compare DVD disc with other discs:

	DVD				LD	SVCD	VCD	CD
Encode method	Digital/MPEG II				Analog	Digital	Digital/MPEG I	Digital
Capacity	Single-side single-layer 4.7G	Double-side single-layer 8.5G	Single-side double-layer 9.4G	Double-side double-layer 17G	/	650MB	650MB	650MB
Playing Time	133 minutes	242 minutes	266 minutes	484 minutes		Single-side 60 minutes double-side 120 minutes	45 minutes	74 minutes
Disc diameter	12cm/8cm				30cm/20cm	12cm	12cm	12cm/8cm
Horizontal resolution	More than 500 line				No more than 430 line	No more than 350 line	No more than 250 line	/
Picture proportion	Multiple kinds				One kind	One kind	One kind	/
Subtitle	32 kinds				16 kinds at most	4 kinds	/	/
Language	8 kinds				4 kinds at most	4 kinds at most	2 kinds	2 kinds
Sound quality	48KHz, 96KHz/ 6, 20, 24bit				44.1KHz/ 16bit	44.1KHz/ 16bit	44.1KHz/ 16bit	44.1KHz/ 16bit

# Connecting the TV set to the other video and audio equipment

## Connecting to the other video and audio equipment



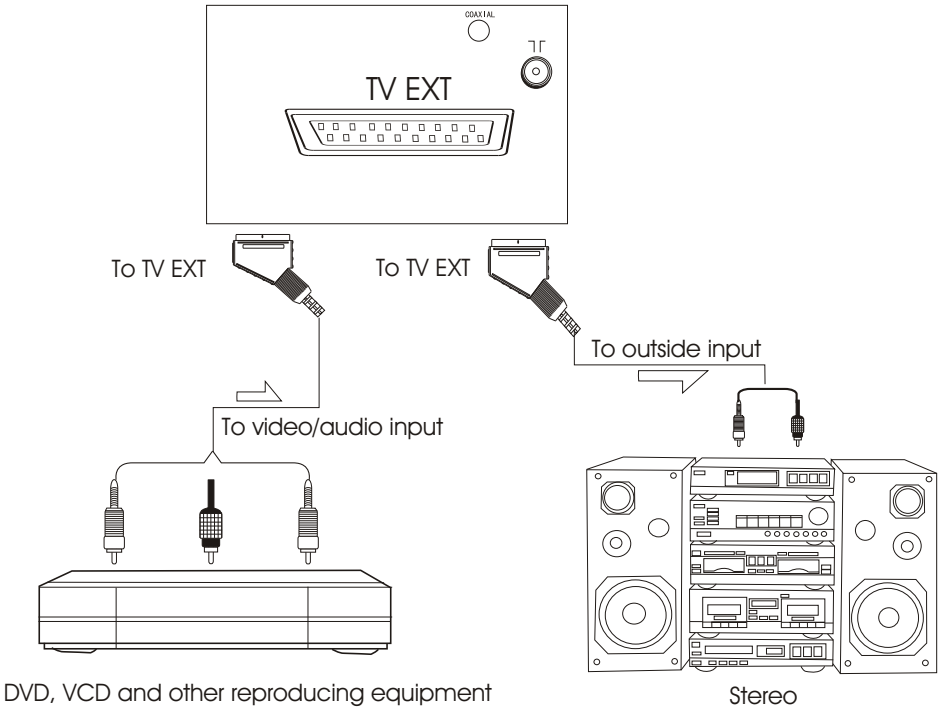













You can connect a stereo to the AUDIO output terminals on the TV set to enjoy sounds of higher quality. VIDEO and AUDIO output terminals output the video and audio signals being monitored by the TV set. The electric levels of video and audio output signals are fixed.



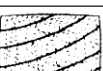

# Troubleshooting guide

- To assist in location possible faults use help guide below.

BREAKDOWN PHENOMENON		CHECKING
PICTURE	SOUND	
 <p>Picture with snow</p>	 <p>Noise</p>	The aerial direction and connection
 <p>Double or Triple Image</p>	 <p>Normal</p>	This is called ghosting which can be minimized with an outside aerial, and good quality cable and terminations. Altering the aerial direction can also minimize this effect.
 <p>Disturb</p>	 <p>Noise</p>	Electrical interference which can be caused by cars, motorbikes etc, Fluorescent lamps and dirty insulators on overhead power cables.
 <p>Normal</p>	 <p>No sound or 1 speaker no sound</p>	<ol style="list-style-type: none"> <li>1. Volume Sound mute.</li> <li>2. Only 1 speaker has no sound. Press S.STD button to choose USER mode, then check whether the BALANCE item value in SOUND menu equal to 0. Adjust the BALANCE item in SOUND menu as you wish in USER mode.</li> </ol>
 <p>No Picture</p>	 <p>No sound</p>	Ensure that the power supply is connected to the TV set and turned on. Also ensure that the TV set is not in "Listen Mode" or that the brightness and contrast are not turned down.
 <p>No colour</p>	 <p>Normal volume</p>	Adjust colour control
 <p>Scramble</p>	 <p>Normal or Weak Volume</p>	Adjust channel again
 <p>Colour Spot</p>	 <p>Normal volume</p>	Colour Purity fault which can be caused by moving the TV set, placing magnets near the TV screen or turning on/off household appliances such as vacuum cleaners near the TV set. Turn the TV off with the mains power switch for 15 minutes. When the power is turned on again the TV set will automatically degauss the picture. In severe cases leave the TV set turned off overnight.

Note:

1. If the fault can not be repaired using the above guide consult with your local authorized service center.
2. The TV set must only be repaired by a qualified registered service person. Never attempt to remove the back cover as the TV set has dangerous voltages inside that may cause a fatality or fire.
3. The cabinet may produce the occasional "snapping sound" This is normal and caused by the materials in the cabinet expanding with room temperature changes.

## Specifications

- The specifications offered you here are only for reference and, with the improvement of the products ,there may be some different between the description and the practicality.

### Specifications

Colour system	PAL,SECAM, AV NTSC
Sound system	BG,DK
Picture tube	21"colour picture tube (51cm viewable)
Sound output power	2X2W (10% THD)
Power requirements	AC 110V-250V~ 50Hz
Power consumption	≤ 80W
Dimension	504 (Width) x482 (Depth) x512 (Height) (mm)
Accessories	Remote control X1 Owner's manual X1 Battery(AA) X2 Warranty card x1

